

WELCOME TO ISCAR'S 2023 WORLD

Tool Craft for Aircraft

Selecting the right cutting tool for efficient machining of aluminum [pg. 4]

Barrel Cutter Shapes a New Milling Trend

Wavy cutting-edge shape considerably reduces delamination and burrs [pg. 12]

On High RPM

HSM toughens accuracy, reliability, and safety requirements for spindle extensions [pg. 24]

CNC Technology Requires Digitized Tools

Smart manufacturing and network technologies [pg. 34]



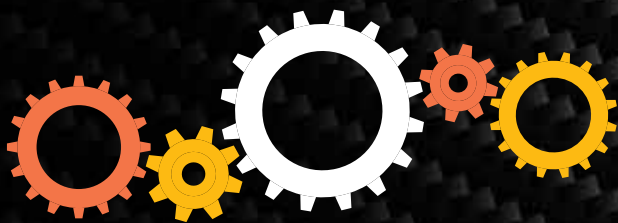

INDUSTREALIZE

TRANSFORM INDUSTRY

Member IMC Group
iscar
www.iscar.com

Table of Contents

Tool Craft for Aircraft	4
To Hold Effectively	12
Super Effectiveness is Required for Machining Superalloys	18
On High RPM	24
High-End Multi-Presence	28
CNC Technology Requires Digitized Tools	34

TOOL CRAFT FOR AIRCRAFT



In machining aerospace components, the main challenges relate to component materials. Titanium, high-temperature superalloys (HTSA), and creep-resisting steel are difficult to cut and machining is a real bottleneck in the whole aircraft supply chain. Poor machinability of these materials results in low cutting speeds, which significantly reduces productivity and shortens tool life. Both these factors are directly connected with cutting tools. In fact, when dealing with hard-to-machine typical aerospace materials, cutting tool functionality defines the existing level of productivity.



Modern aircraft, especially unmanned aerial vehicles (UAV), feature a considerably increased share of composite materials. Effective machining composites demand specific cutting tools, which is the focus of a technological leap in the aerospace industry. Aircraft-grade aluminum continues to be a widely used material for fuselage elements. It may seem that machining aluminum is simple, however, selecting the right cutting tool is a necessary key to success in high-efficiency machining of aluminum. A complex part shape is a specific feature of the turbine engine technology. Most geometrically complicated parts of aero engines work in highly

corrosive environments and are made from hard-to-cut materials, such as titanium and HTSA, to ensure the required life cycle. A combination of complex shape, low material machinability, and high accuracy requirements are the main difficulties in producing these parts. Leading multi-axis machining centers enable various chip removal strategies to provide complex profiles in a more effective way. But a cutting tool, which comes into direct contact with a part, has a strong impact on the success of machining. Intensive tool wear affects surface accuracy, while an unpredictable tool breakage may lead to the discarding of a whole part.

Selecting the right cutting tool is a necessary key to success in high-efficiency machining of aluminum

Advanced multitasking machines, Swiss-type lathes, and live tooling lathes have profoundly changed manufacturing small-size parts of various hydraulic and pneumatic systems, actuators, and accessories, which are used in aircrafts. Consequently, the aerospace industry requires more and more cutting tools that are designed specifically for such machines to achieve maximum machining efficiency. A cutting tool – the smallest element of a manufacturing system – turns into a key pillar for substantially improved performance.

Therefore, aerospace part manufacturers and machine tool builders are waiting for innovative solutions for a new level of chip removal processes from their cutting tool producers. The solution targets are evident: more productivity and more tool life. Machining complex shapes of specific aerospace parts and large-sized fuselage components demand a predictable tool life period for reliable process planning and a well-timed replacement of worn tools or their exchangeable cutting components.

The smallest element of a manufacturing system, turns into a key pillar for substantially improved performance

NEOSWISS
INDEXABLE HEADS

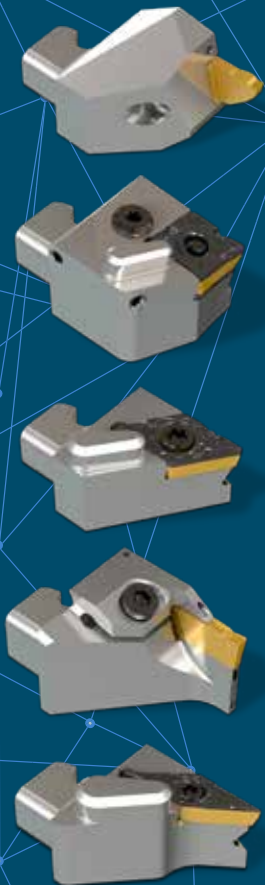



Coolant jet

In machining titanium, HTSA and creep-resisting steel, high pressure cooling (HPC) is an efficient tool for improving performance and increasing productivity. Pinpointed HPC significantly reduces the temperature at the cutting edge, ensures better chip formation and provides small, segmented chips. This contributes to higher cutting data and better tool life when compared with conventional cooling methods. More and more intensive applying HPC to machining difficult-to-cut materials is a clear trend in manufacturing aerospace components. Understandably, cutting tool manufacturers consider HPC tooling an important direction of development. ISCAR, one of leaders in cutting tool manufacturing, has a vast product range for machining with HPC. ISCAR has expanded its range by introducing new milling cutters.

In the 1990's, ISCAR introduced the **HELIMILL** – a family of indexable milling tools, which carried inserts with a helical cutting edge. The new design provides constant rake and relief angles along a mill cutting edge and results in a smooth and light cut with a significant reduction in power consumption. The **HELIMILL** principle turned into a recognized concept in the design of the 90° indexable milling cutters. The **HELIMILL** was modified and underwent changes which led to additional milling families and inserts with more cutting edges. The excellent performance and its close derivatives of the original tools ensured their phenomenal popularity in metalworking. Therefore, by adding a modern HPC tool design to the proven **HELIMILL** family was a direct response to customer demand and the next logical tool line to develop.

In Turning Solutions, ISCAR considerably expanded its line of assembled modular tools comprising of bars and exchangeable heads with indexable inserts. With the use of a serrated connection, these tools fit a wide range of heads with a range of different insert geometries, including threading and standard ISO turning inserts for different applications for greater flexibility.

The bars have both traditional and anti-vibration designs and differ by their adaptation: cylindrical or polygonal taper shank. A common feature for the modular tools is the delivery of internal coolant to be supplied directly to the required insert cutting edge.

Depending on the diameter of a cylindrical-shank tool, the maximum coolant pressure varies from 30 to 70 bars, while the tools with polygonal taper shank facilitate ultra HPC at a pressure of up to 300 bars. The efficient distribution of coolant increases the insert's tool life by reducing the temperature and improving chip control and chip evacuation, substantially increasing this application line in the aerospace industry.



WHISPERLINE
ANTI-VIBRATION

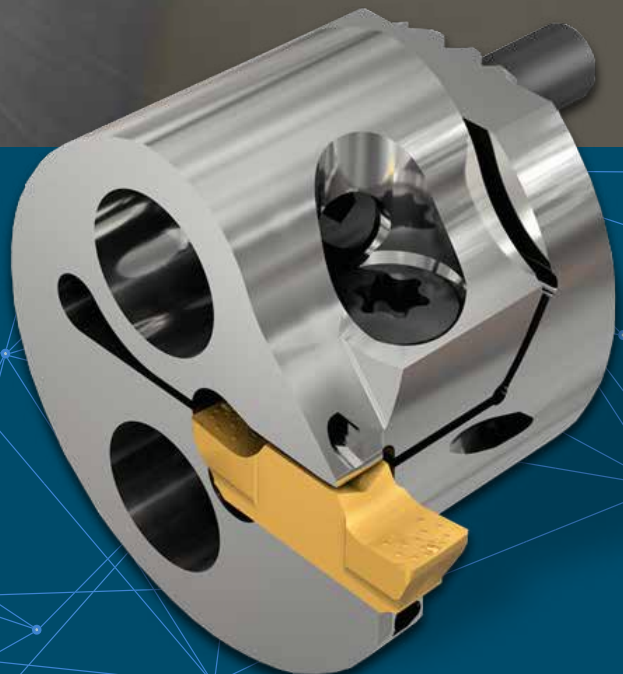

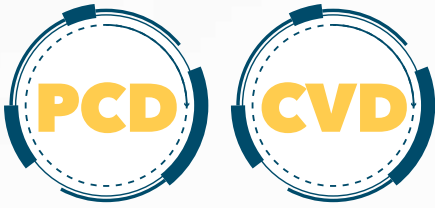

30XD



Drilling solutions

ISCAR developed a range of new drills that are intended especially for composite materials. To increase abrasion resistance, these drills have a cutting part made from extra hard polycrystalline diamond (PCD) or diamond coating. Depending on the drill diameter, the PCD cutting part is known as a nib or a wafer; and in both cases is suitable for regrinding up to 5 times. The CVD diamond-coated solid carbide drills are attractive because of another specific design feature, the wavy shape of main cutting edges. In machining composite materials, a tool produces more chattering than a cutting effect. The wavy shape of the cutting edge considerably reduces delamination and burrs, especially when drilling carbon fiber reinforced plastics (CFRP) and carbon laminates.

In addition to composites, the diamond-coated drills are suitable for machining other high-abrasive engineering materials. If necessary, these drills can be delivered with optional tool through coolant holes. Drilling deep, small-in-diameter holes is a common operation in manufacturing aerospace components. ISCAR's new solid carbide drills in the diameter range of 3-10 mm (0.125"-0.391") are intended specifically for such an operation. The combination of a split point geometry, a double-margin design, polished flutes, a multi-layer coating and coolant holes provides a noteworthy tool family for effective one-pass drilling holes with a depth of up to 50 hole diameters in difficult-to-cut austenitic and creep-resisting steels and ferrum-based alloys.

The wavy shape of the cutting edge considerably reduces delamination and burrs, especially when drilling carbon fiber reinforced plastics and carbon laminates

Complex Shaped Parts

Airfoils of aero-engine turbines and compressors, impellers, and integrally bladed rotors (IBR) have a complex shape that is defined by aerodynamic requirements. New developments, which are directed on improving aero-engine efficiency, add to this complexity. Advancement of technology brought new methods for producing formed parts, in particular 3D printing, which significantly diminishes material stock for chip removal. However, machining remains the most common method for the final shaping method in manufacturing geometrically complex aerospace components. The progress in 5-axis machining and CAD/CAM systems has enriched the manufacturer's solution pool to overcome difficulties in component production. Barrel-shaped milling cutters have good prospects in 5-axis machining of aerospace components with complex surfaces. ISCAR has developed a series of barrel-shaped cutters of 8 - 16 mm (.312" - .500") in two designed configurations: solid carbide endmills and exchangeable heads with a **MULTI-MASTER** threaded connection. The introduction of these tools into the machining processes is a major advantage of intensifying blade manufacturing.

NEOBARREL
PROFILE MILLING

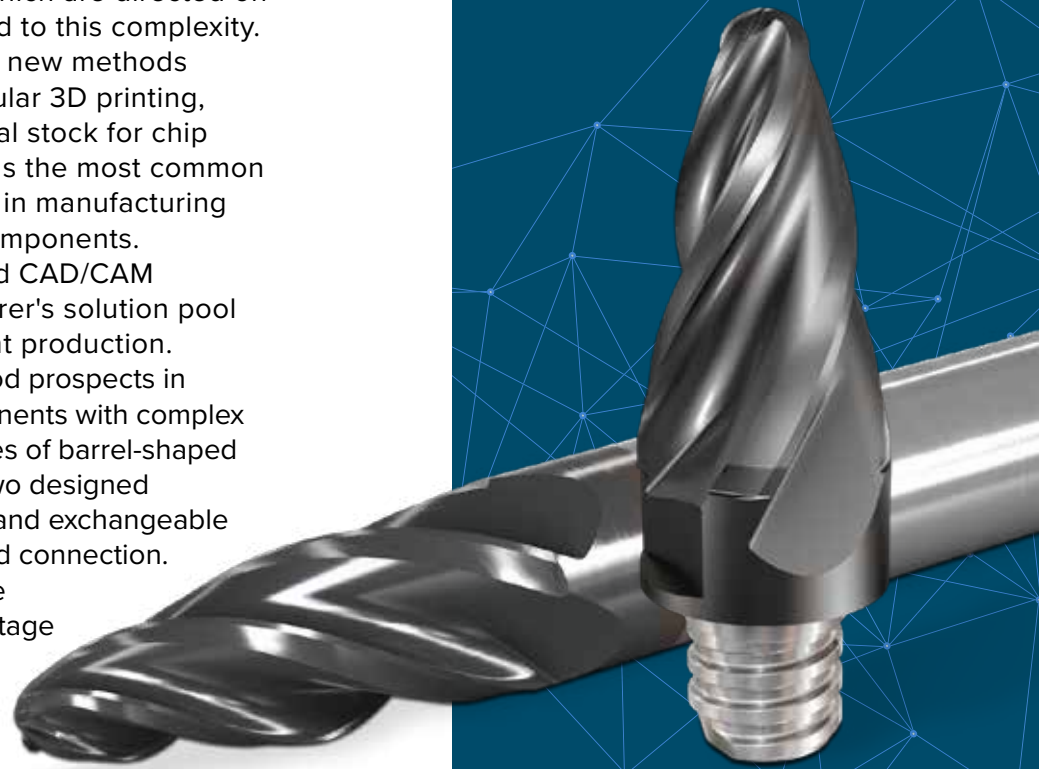



NEOCOLLET
INTEGRAL COLLET

Promising multitasking

Effectiveness of chip-removal processing on compact multi-tasking machines and Swiss-Type lathes depends largely on correct tool selection. Demands to increase productivity require maximum tool holding stiffness and limited working space to minimize tool overhang. Recently, ISCAR introduced **NEOCOLLET**, a new tool holding family, which provides an alternative to clamping tools with spring collets. One of the typical toolholders in this family has a tapered shank that can be mounted in a collet chuck directly, ensuring a rigid and reliable connection to improve tool performance. The new family includes the holders for ISCAR **T-SLOT** exchangeable slot and face milling heads from cemented carbide.

As mentioned, applying high pressure cooling can substantially change machining results especially when deal with titanium, HTSA and difficult-to-cut stainless steel – the main materials for aircraft hydraulic and pneumatic systems and light-sized accessories. The new turning tools with a square shank and a reliable screw clamping mechanism for 55° rhombic insert facilitate HPC in longitudinal, face and profile turning operations on small-diameter parts.



TO HOLD EFFECTIVELY

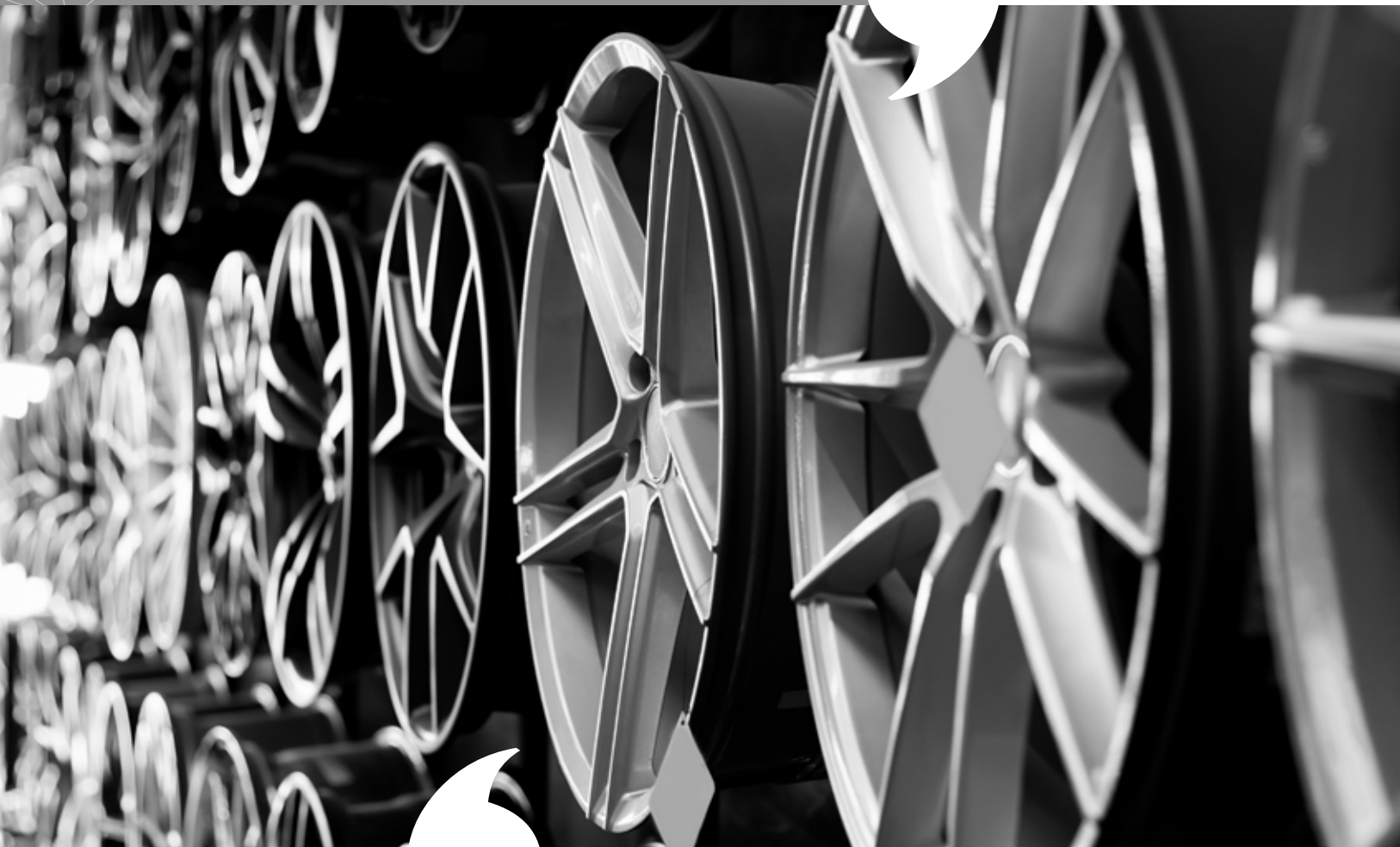

Toolholders were designed for mounting cutting tools reliably. They also facilitate the torque transmission from a machine spindle to a rotating tool. Indeed, well-established tool clamping principles, the need for wide interchangeability and unification, and normalized designs of machine tool adaptations have resulted in well-defined standards, which specify detailed toolholder parameters. Time places new demands on machining, which has transformed to new requirements for machine tools, cutting tools and toolholders – both elements of a chain that enables the recognition of machine tool capabilities possible when machining part of a surface. The toolholder relates to the most "conservative" link of the chain and has undergone fewer revolutionary changes.

A hand is shown in the lower right corner, pointing its index finger towards a glowing network of white nodes and lines. The network is composed of numerous small white circles connected by thin white lines, creating a complex web-like structure. The background is a dark blue gradient, and the overall lighting is bright and futuristic, with a strong blue glow emanating from the point where the hand touches the network.

Smart manufacturing of tomorrow demands intelligent toolholders to exchange data in the formed Internet of Things (IoT). This will lead to creating new information capabilities of toolholders by adding more and more electronic units. Even today, built-in chips provide various data about a toolholder that communicates with machine tools, industrial robots, storage devices, and more. Adding a new data function is no doubt an extremely important direction in toolholding development. However, it does not cancel the common way of an improved mechanical design, which may look a little bit prosy when compared to the enthusiastic data intelligence of smart tooling.

Recent improvements in toolholder designs are distinctly seen in the following areas.

1. Heat-shrink chucks

High-speed machining (HSM) methods have brought tool balancing requirements to new heights. In HSM, the dynamic characteristics of a tool cannot be separated from a toolholder, and a particular focus must be given to the assembly on the tool and the toolholder. Minimizing the unbalance of such an assembly is one of the challenges tool developers face. They have tried to guarantee the required balance parameters at the design stage before production. This engineered balance design cannot replace "physical" balancing of a real assembly, but it substantially diminishes the mass unbalance of a future product and makes "physical" balancing much easier. Axisymmetric heat-shrink chucks optimally meet the requirements of a balanced toolholder for HSM already in the design stage. This explains why the advance of heat-shrink chucks is of priority.

2. Coolant supply

A pinpointed coolant supply through a tool body, when a coolant flow is directed to a cutting zone, significantly improves machining performance.

3. Modular quick-change tooling

A modular design principle considerably simplifies finding the optimal configuration of a tool assembly and diminishes requests for special tools.

4. Long-reach applications

Long-reach machining applications, which require high overhang of a tool assembly, feature poor stability. Increasing vibration strength of the assembly is one more trend of toolholder development.

5. Polygonal taper connection

The ISO-standardized polygonal taper adaptation has proven itself and become common in multitasking machines and turning centers.



JS GJET HSK A63

S.N 373299017



Min.20-Max.40 bar

isemf



Time puts new demands on machining, which has transformed to new requirements for machine tools, and, consequently, to cutting tools and toolholders



Recently, ISCAR expanded its family of heat-shrink holders by adding new chucks with C8 polygon taper shank. The chucks offer several bore sizes from 6 to 32 mm (.25-1.25"). The introduced products feature coolant channels along the chuck bore to provide effective coolant supply to the cutting edge of a clamped tool.

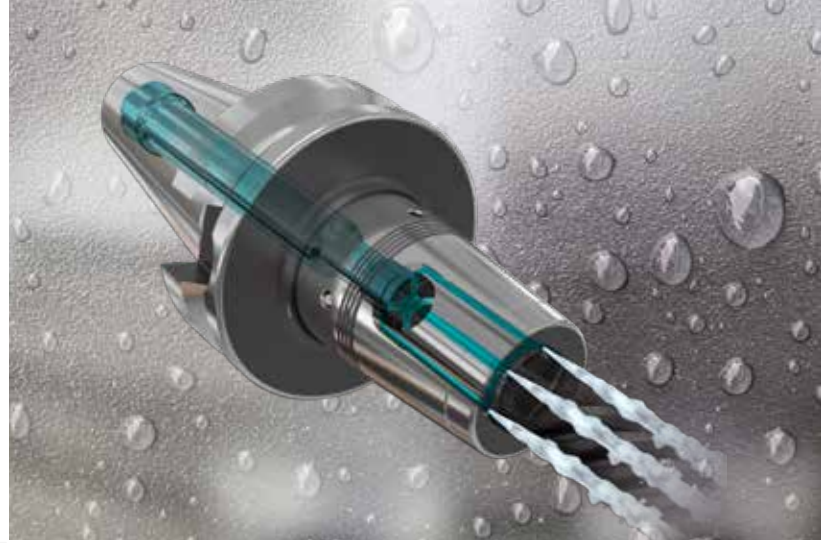

Due to increasing popularity of the polygon taper adaptation, ISCAR has developed a new tool family for external and internal turning and threading applications. A modular concept of the family enables various tool assemblies using a wide range of cutting heads with indexable inserts that are mounted on toolholders with polygon taper shanks by serration-face connection.

What else can be new in ER spring collets? Tool manufacturers have developed a rich variety of precise collets that offer coolant supply capability. For example, ISCAR's new updated ER rubber sealed collets with an extremely narrow collapse range ensure better clamping force, maintain high runout accuracy of 0.005 mm (.0002"), and facilitate 4 cooling jets. ISCAR's integral collets, tools with a tapered shank for direct mounting in ER chucks, are accurate and rigid tools, and are considered toolholders themselves: the front of the collet has its own adaptation for mounting cutting heads with indexable inserts or are fully made from cemented carbides.



Hydraulic chucks ensure high gripping torque that is vital for heavy-duty machining. During the last years, ISCAR extended its product range of hydraulic chucks, and they are now available with BT-MAS, DIN 69871, and HSK shanks. In addition to a high-torque transmission and fast tool-change capabilities, the hydraulic chucks are characterized by excellent vibration damping properties and high accuracy. ISCAR developed a system of quick-change assembled tools specifically for turning aluminum wheels. A tool assembly comprises of a cutting head and a holder.



The head is mounted on the holder by use of a dovetail connection. The dovetail mechanism assures full-face contact between the holder and the head with very high clamping forces and can resist tough cutting conditions when turning the wheels. The holders are produced with VDI40, VDI50 or round shanks.

We can see that progress in toolholding is far from exhausting the resources of advanced designing. Although high-quality toolholders have reached the right level of performance to meet the needs of today's manufacturers, the smart factory of tomorrow demands an even higher level.

SUPER EFFECTIVENESS

is Required for
Machining Superalloys



Superalloys - metal alloys, which reflect their complex alloyed structure, have become one of the main engineering materials for a long time. They feature extremely high elevated temperature strength, and therefore often are referred to as high-temperature superalloys (HTSA) or heat-resistant superalloys (HRSA). The history of superalloys started with the development of gas-turbine engines that required reliable materials for high operating temperature ranges. As a result of intensive research and progress in metallurgy, modern superalloys (SA) provide a long service life for working temperatures more than 1000°C.



Understandably, the largest superalloy consumers today are aero - and marine engine producers. Superalloys are also very common in the medical industry, which effectively use them for prosthetic implants in orthopedic surgery. In addition, superalloys have become widespread in power generation and the oil and gas industries as crucial materials for essential parts of various devices.



Exceptional high-temperature strength and corrosion resistance are the undeniable advantages of superalloys. However, there are two sides to the coin: superalloys are not only highly priced, but their machinability is poor, which can pose challenges to manufacturing. The specific cutting force that characterizes the resistance of the material to chip removal and defines the mechanical load on a cutting tool is high for superalloys. Although the main difficulty is heat, superalloys have poor thermal conductivity. Elemental and loose chips, which are generally generated when machining superalloys, do not provide adequate heat dissipation from the cutting zone. A tendency to work hardening makes the situation worse.

The manufacturer deals with various SA workpieces: cast, wrought, sintered, etc. The workpiece fabrication methods also have an impact on machinability. For example, abrasiveness of forged workpieces higher than cast ones substantially lower in comparison with sintered workpieces.

Consequently, a cutting tool is under significant thermal and mechanical load, which dramatically reduces tool life. Therefore, in machining superalloys,

the cutting speed directly connected with the heat generation during chip removal is considerably lower when compared to other common engineering materials such as steel or cast iron. The direct result of the cutting speed limitation is poor productivity. Overcoming machining difficulties and increasing productivity are the main challenges for the manufacturer of SA parts.

According to ISO 513 standard, superalloys together with titanium alloys relate to the ISO S group application. Depending on the prevailing element, superalloys are divided into three types: iron (Fe), nickel (Ni) and cobalt (Co) based alloys. Machinability drops in the specified order; from the iron-based alloys, which can be compared with austenitic stainless steel, to cobalt-based alloys that represent the most hard-to-cut materials in the group.

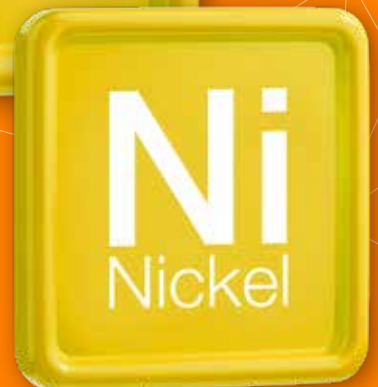

Increasing efficiency of machining superalloys has become the focus of various scientific research and technological improvements. Their result was a significant advance in producing SA components. Manufacturing has effectively embraced new machining strategies and innovative methods of cutting coolant supply, such as high-pressure cooling (HPC), minimum quantity lubrication (MQL) and even cryogenic cooling has successfully been introduced. This has taken the productivity of machining superalloys to a new level. However, like in the case of titanium alloys, the key element for improving the productivity of SA machining is a cutting tool that directly removes material layers from a workpiece that produces chips.

The key element for improving the productivity of SA machining is a cutting tool

Today, coated cemented carbides are the most common materials for cutting tools for machining superalloys. The development of a carbide grade, in which strength and wear resistance will be mutually complemented is a tricky process that requires an appropriate carbide substrate, coating composition, and coating method.

If tool materials are connected mostly with material sciences and metallurgy, cutting geometry is more in the tool design field. Ensuring high-performance geometry requires deep engineering knowledge and technology skills. On the one hand, to minimize heat generation and work hardening, a positive rake angle, a large enough clearance angle, and a sharp cutting edge are needed. On the other hand, such a shape weakens the cutting edge that should withstand a considerable mechanical load. Therefore, the correct designed cutting-edge condition becomes a critical success factor. Sintered carbide inserts have the advantage of enabling complex chip forming and chip breaking shapes for insert rake faces. Today, computer modeling of chip formation and pressing processes using finite element methods provide an effective tool to optimize the shapes that are already in the design stage. In solid endmills, a variable pitch design results in improved vibration strength. Cutting edges of these endmills are produced by grinding operations, and to eliminate flaking and edge defects, strict adherence to technological process requirements is highly important.





NEOBARREL
PROFILE MILLING



Carbide grade IC806, which had been introduced over the last few years for face grooving superalloys and austenitic stainless steel, was successfully adopted by ISCAR's threading and deep drilling lines. This grade has a hard submicron substrate and PVD TiAlN/AlTiN coating with post-coating treatment according to ISCAR's SUMO TEC technology. IC806 provides notable resistance to flaking and chipping and maintains reliable and repeatable results. In machining superalloys by solid carbide endmills and exchangeable heads, grade IC902, which combines ultra-fine grain substrate and nano-layer

PVD TiAlN coating, ensures extremely high wear resistance and prolongs tool life. This grade has demonstrated very good results in producing devices for replacement knee and hip joints that are made from difficult-to-cut cobalt-chrome alloys.

ISCAR has significantly extended the range of products for ISO S applications made from various cutting ceramics such as silicon nitride, SiAlON, and whisker-reinforced grades. The newly introduced ceramic items have replenished both indexable inserts and solid endmills.



ROUND MILL



ISCAR has enriched the range of solutions intended for high-pressure cooling by new indexable cutter bodies and tool holders

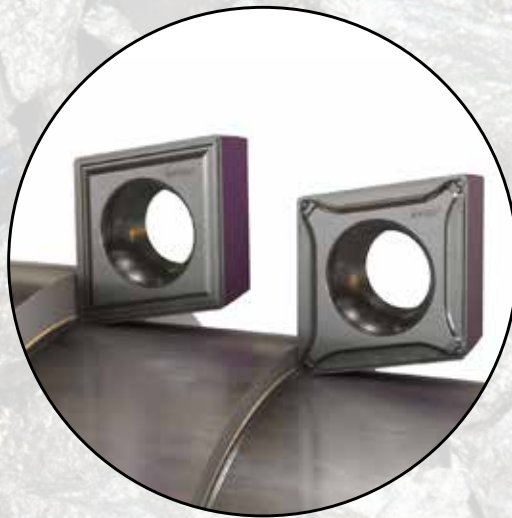

The latest rake face designs F3M and F3P for ISO standard turning inserts are intended specifically for hard-to-machine austenitic stainless steel and superalloys. Their positive rake-angle geometry reduces the cutting force and ensures smooth cutting action, while the set of deflectors on the rake face improves chip control.

In ceramic double-sided inserts for turning and milling tools, ISCAR has added new chamfered and combined (chamfered and rounded) cutting-edge condition options for tough applications. ISCAR has enriched the range of solutions intended for high-pressure cooling by new indexable cutter bodies and tool holders. For example, thermal shrink chucks with polygonal taper shanks, which have coolant jet channels along the central bore, have been replenished by the toolholder product line.

On High RPM



High-speed machining (HSM) has not only led to a significant difference between machine tools but has also brought awareness to the high-speed spindle; perhaps, the most important and central component of high-speed machine tools and a key factor for the success of HSM.

Operating a spindle with high rotation speed and gaining the optimal balance between the provided speed and torque is the main task of high spindle engineering. The spindle's performance depends on several different factors. One of the main factors relates to the design concept of a single- or combined twin-motor bearing system, seal components, and a tool retention method.

When machining, the spindle is not in direct contact with the workpiece but interacts with it through another technological system – the cutting tool. This connection acts as a conductor and should transform the impressive capabilities of a high-speed spindle into improved machining results. Another element between the cutting tool and the spindle is the toolholder which is fitted into the spindle. The poor performance of this small assembly, the cutting tool and toolholder, may reduce the function of the spindle to zero. Therefore, HSM toughens the accuracy, reliability, and safety requirements for the assembly of the spindle extension.

High-speed rotation generates centrifugal forces. In HSM, when compared with traditional machining methods, these forces grow exponentially and turn into a significant load on a cutting tool which determines the tool's durability. In indexable milling, high centrifugal forces may cause insert clamping screws to break, inserts to loosen and a cutter body to fail. Formed fragments can not only damage a machine and a machined part but can be very dangerous to the operator.



HSM toughens the accuracy, reliability, and safety requirements for the assembly of the spindle extension



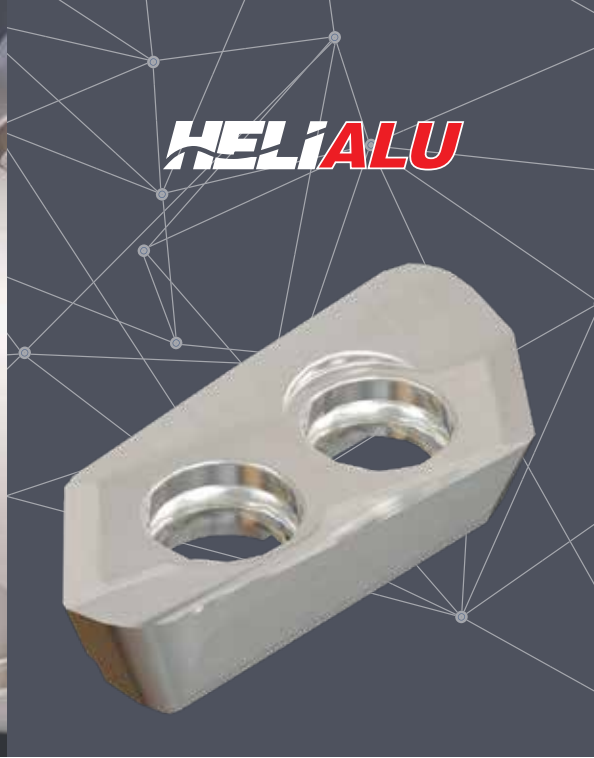

ISCAR's milling cutters HSM90S FAL-22 are intended for efficient milling of aluminum at high-speed rates. They carry large-size inserts that enable up to 22 mm (0.866") depth of cut. The cutter insert pocket has a protruding ridge on the seat bottom surface, and the lower face of the insert has a matching groove which fits into a ridge when assembled. This eliminates insert radial displacement due to strong centrifugal forces at high-speed milling and improves load distribution on the insert clamping screw. The cutter design facilitates reliable milling in a rotational speed range of up to 31000 rpm.

To reduce centrifugal forces, a cutter body should be axially symmetric and highly balanced. There are international and national standards and norms that specify tool balancing grades. When designing indexable milling tools intended for HSM, it is very important to ensure the mass distribution of the body is symmetrical with the body axis. As this theoretical balance relates to a virtual object, it cannot replace the physical balancing of a real body if needed but can substantially diminish the mass unbalance of future products making the "physical" balance much easier.



Solid tools feature higher accuracy and better axial symmetry when compared with indexable cutters. Typically, solid tools are less in diameter and naturally require higher RPM even for the same cutting speed. This explains why the majority of HSM tools are solid.

Normally, such tools are made from coated cemented carbides, although in recent times cutting ceramics as a tool material has become popular for high-speed machining of high-temperature superalloys. Nevertheless, selecting a solid tool, especially milling cutters for HSM may be difficult.

Normally, the overhang-to-diameter ratio for solid carbide endmills (SCEM) is greater when compared with indexable tools. Such a feature, in combination with a flute shape that weakens a tool cross-section, demands specific attention to the vibration strength of a SCEM.

To improve chatter stability, tool engineers often make a tooth angular pitch unequal, and a flute helix variable. This violates the principle of axial symmetry and may give a reverse result. Therefore, an optimal, intelligent design for solid carbide endmills requires engineer ingenuity and appropriate compromising

Modern CAD/CAM systems ensure estimating the dynamic behavior of various products based on their 3D models. Providing such models for cutting tools, toolholders and various accessories is a typical feature of today's serious tool manufacturer.

To conclude, high-speed machining has influenced the need for specific requirements of a cutting tool and toolholder. By meeting these demands, HSM has become a trusted highly engineered, high-speed spindle operation with maximum efficiency.



HIGH-END MULTI-PRESENCE



MULTI-MASTER INDEXABLE HEADS

Back in the early 2000s, the introduction of ISCAR's **MULTI-MASTER** system of rotating tools with interchangeable carbide heads played a significant role in the development of cutting tools. Tool assemblies with exchangeable heads were known long before ISCAR's **MULTI-MASTER**.

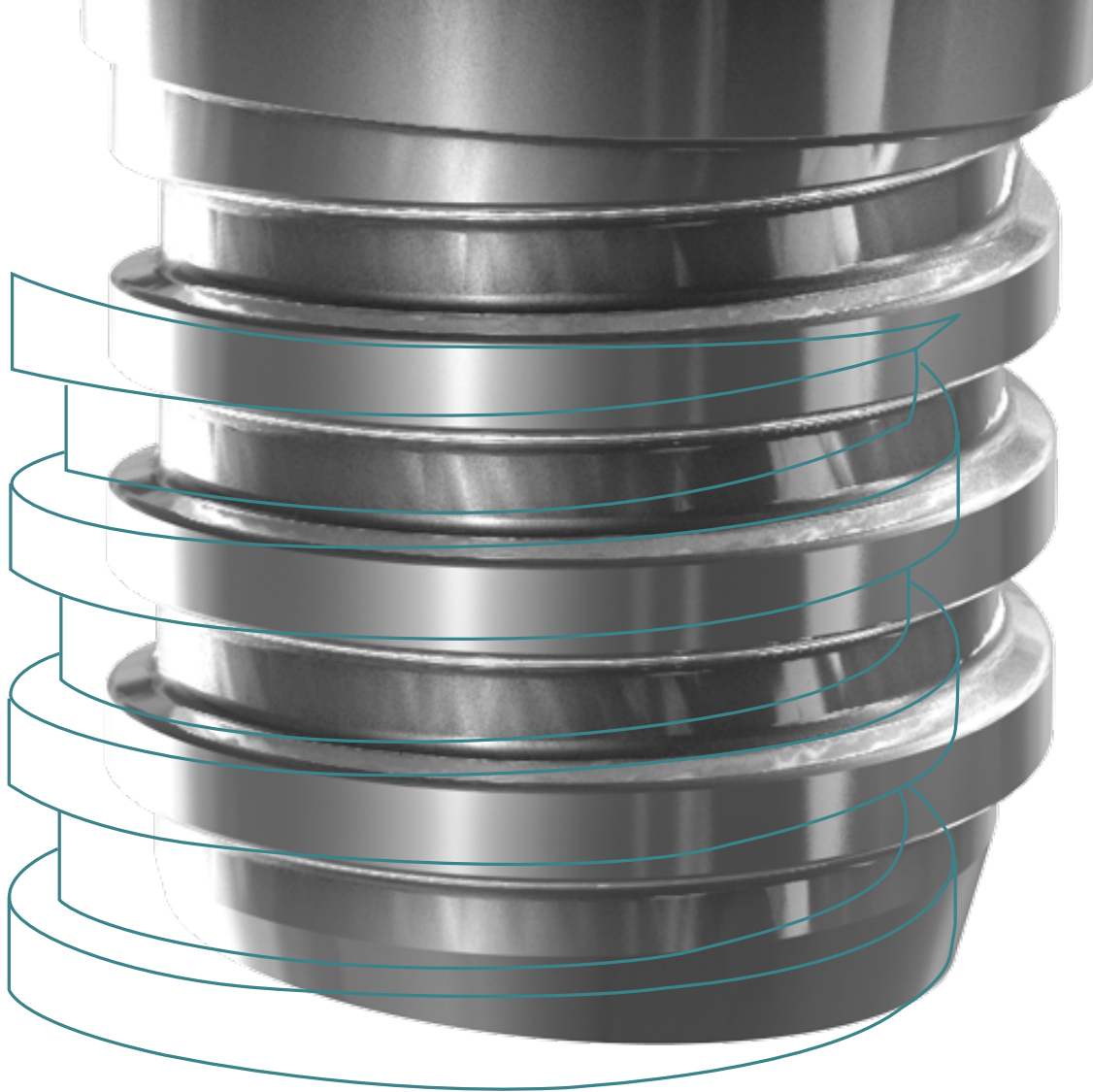

Within the **MULTI-MASTER** product line, heads are secured by using a thread connection. Cemented carbide is a very hard and wear-resistant material and has lower impact strength when compared to high-speed steel. In a threaded carbide part, the thread is a source of stress concentrators that is crucial for tool functioning, especially under cyclic loading. Rotating tools with exchangeable carbide heads are reasonable in a relatively small diameter range, typically 6-25 mm (.25"-1.00"), which limits appropriate thread diameters and the height of a thread profile.

The above points make it problematic to use standard threads and strongly determine a special thread shape to comply with the specifications of the connection. Tools with threaded heads have significant advantages as they demonstrate impressive versatility, provide rational utilization of cemented carbide and are user-friendly with a simple head replacement.

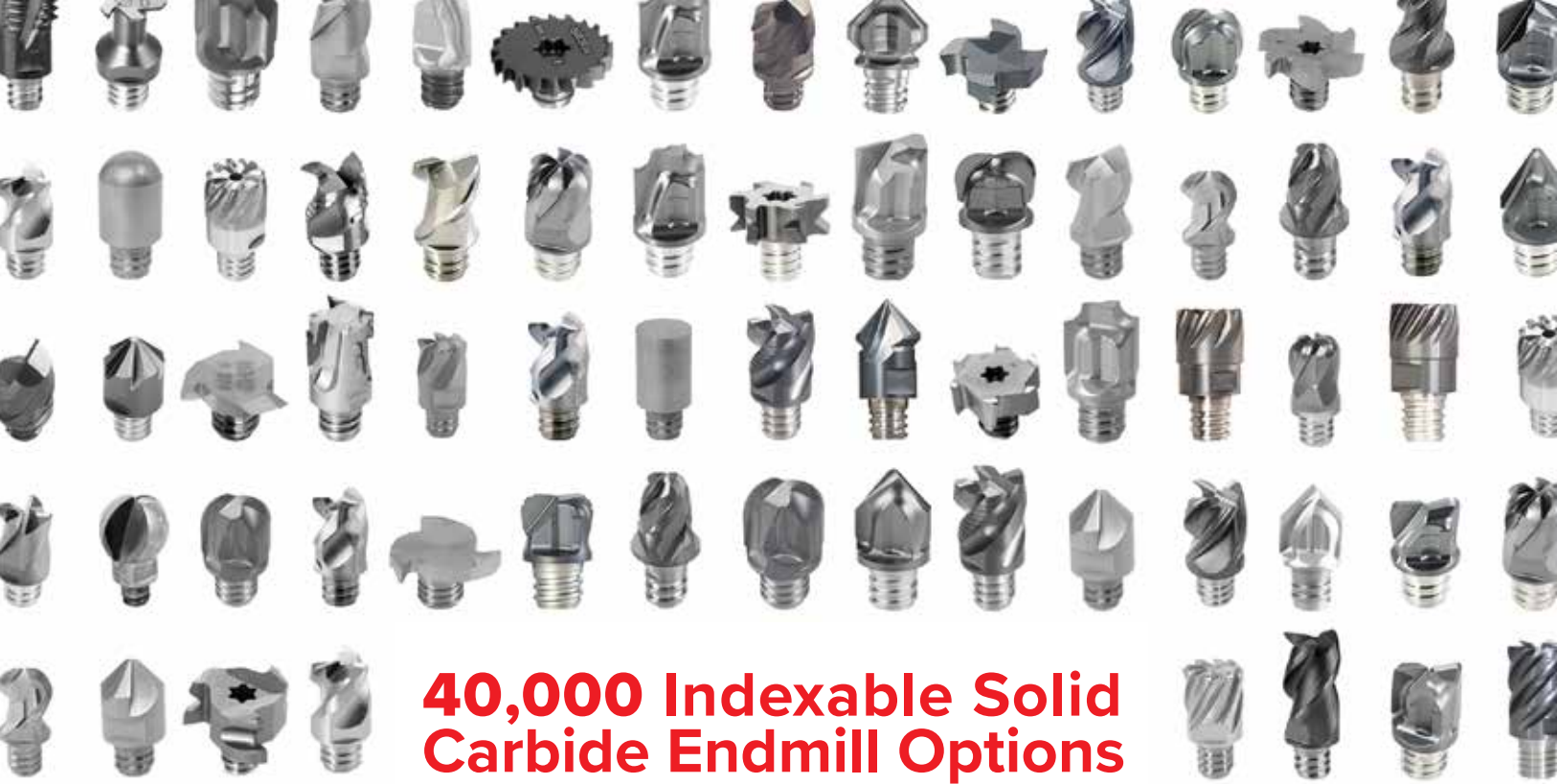

40,000 Indexable Solid Carbide Endmill Options

Aside from the benefits outlined above, which are crucial for tools with exchangeable threaded heads, the **MULTI-MASTER** provides high dimensional repeatability with its face-contact design concept. This concept holds the "no setup" principle for replacing a worn head - no additional setup operations for adjustment are necessary and the head can be changed without removing the tool from the machine.

Another unique aspect of the **MULTI-MASTER** is its very wide variety of heads that cover a broad-spectrum of applications in milling, hole making, engraving, and gearing. In milling operations, these cover square shoulders, faces, 3D surfaces, chamfers, cavities and pockets, slots and grooves, threads, and machining by high-speed- and high-feed milling methods. And in holemaking operations, center and spot drilling, countersinking, etc.





Combining two types of heads is a beneficial combination of two design approaches fully ground heads from solid blanks and heads from pre-shaped sintered inserts. Together with a wide choice of shanks, adaptors, and reducers significantly simplifies the process of finding the best tool configuration for a variety of metal cutting operations. Apart from that, the line and its products are ideal for tailor-made products, which makes tool customization much easier.

A new horizon of applications starts with ISCAR's new thread size T12, intended for end milling heads with a 32 mm (1.25") diameter. Even though solid carbide endmills in this diameter are not common due to their high cost, there are industrial sectors, such as aerospace that need such tools. Assemblies with exchangeable heads provide a much more cost-efficient solution and ISCAR is enthusiastic about its prospects of new developments. It's important to note that among ISCAR's introduced products, there are 5-flute endmill heads with variable helix that were designed specifically for machining difficult-to-cut titanium alloys and high temperature materials (ISO S group of application). The heads have a corner radius of 4 and 5 mm (.120", .250", .375"), which are typical for aircraft part production.



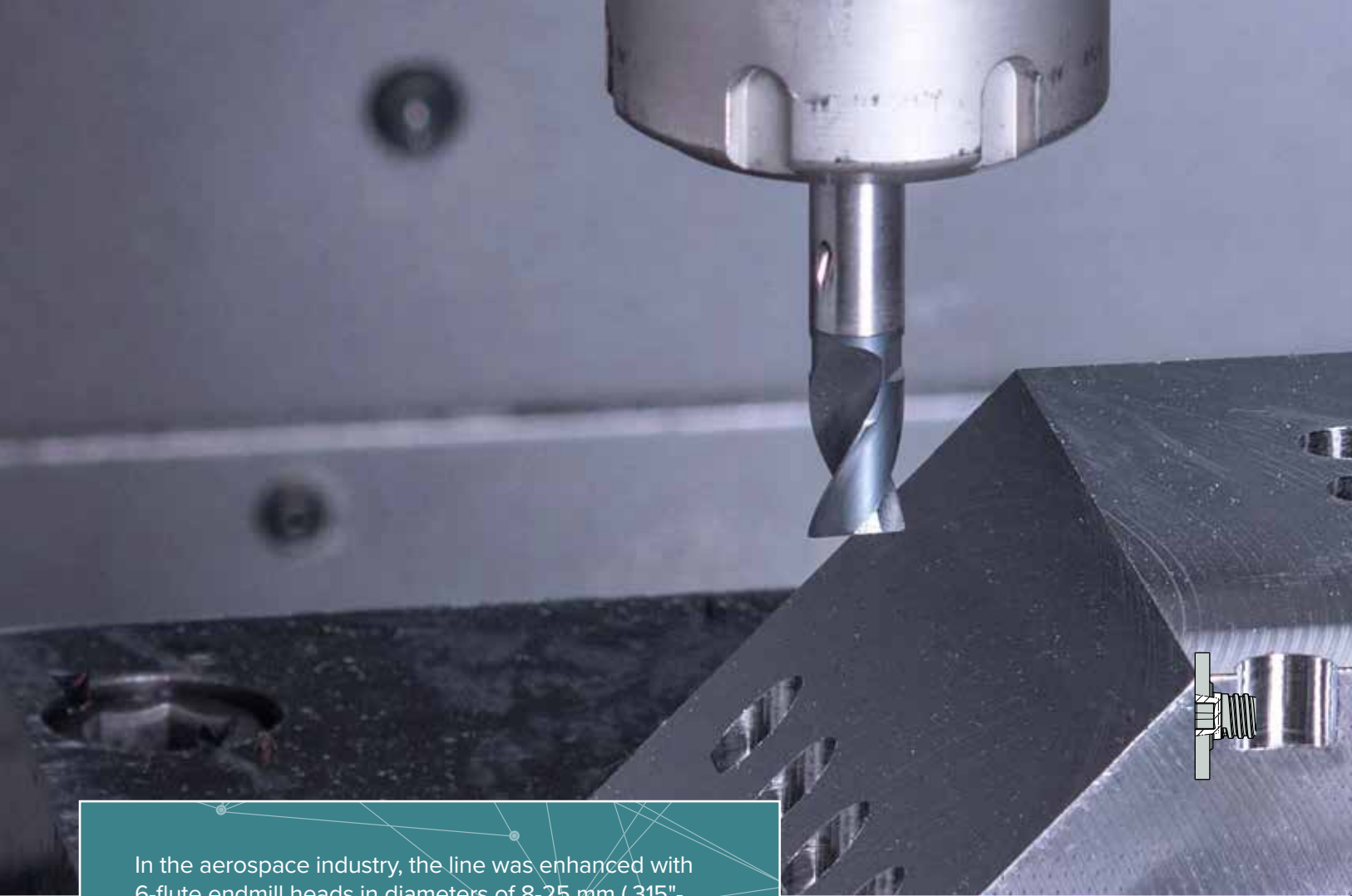

In the aerospace industry, the line was enhanced with 6-flute endmill heads in diameters of 8-25 mm (.315"-1.00") for machining titanium, including hard-to-cut β - and near β -alloys especially by the trochoidal milling method. The heads feature a combination of different helix and variable angular pitch to improve chatter stability. A typical aircraft countersunk screw requires a 100° countersink. The same angle is often needed for riveting. The **MULTI-MASTER** provides an appropriate solution with its newly developed 2-flute countersink heads with 100° -point angle in diameters 9.525-19.05 mm (.375"-.750"). The heads are also suitable for chamfering and spot drilling. The growth of 5-axis CNC machines has brought new efficient strategies for milling complex 3D shapes. This has increased the demands for cutting tools with a specific geometry, i.e., barrel endmills. In hole making, the recently introduced precise flat bottom drilling heads have considerably expanded the line applicability in shallow drilling operations for steel, stainless steel, and cast iron (ISO P and K groups of application) including direct drilling inclined surfaces. The head diameter tolerance meets the accuracy grade h7, while the head drilling capabilities extend up to 1.2 of the diameters.



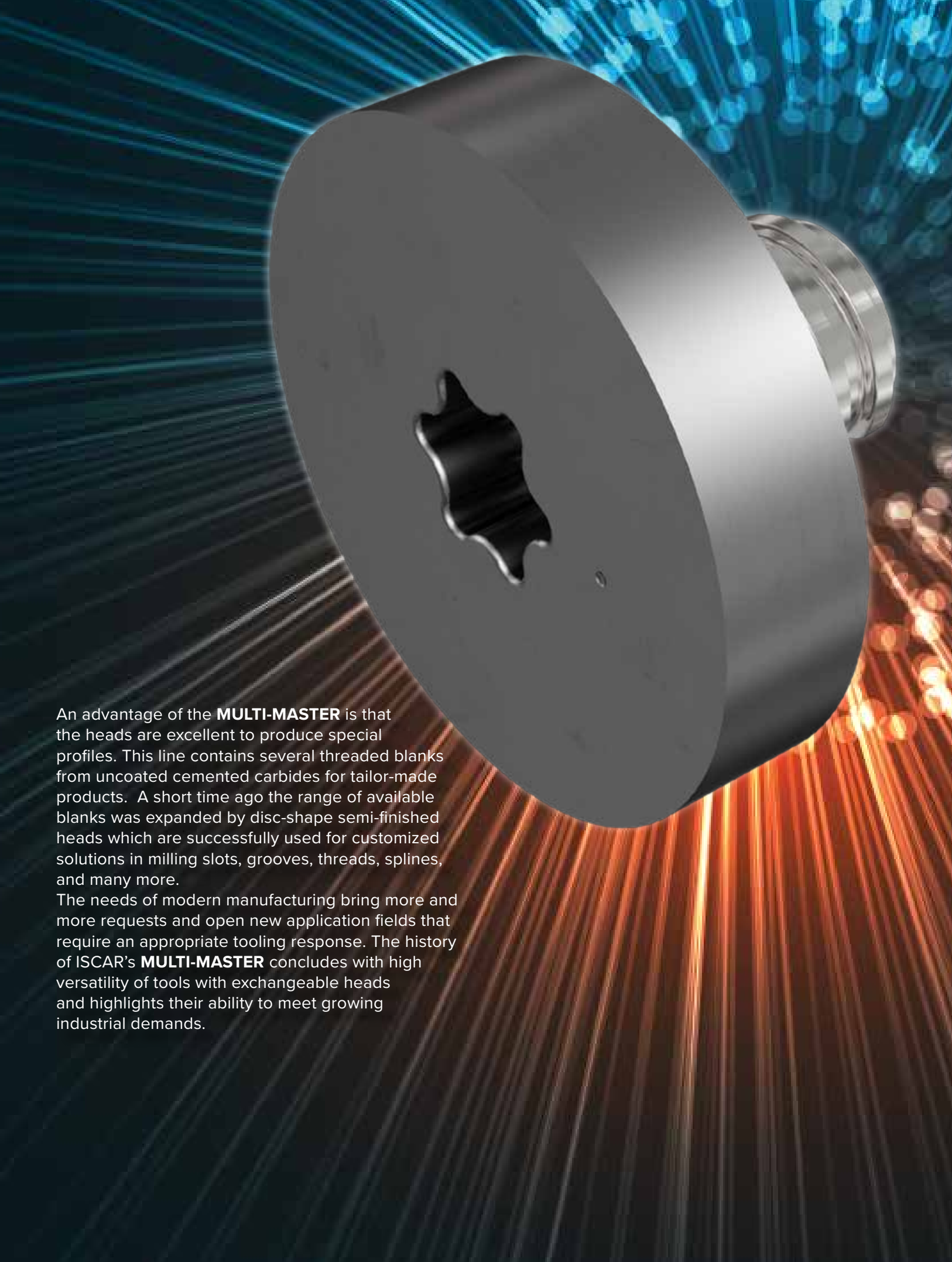

An advantage of the **MULTI-MASTER** is that the heads are excellent to produce special profiles. This line contains several threaded blanks from uncoated cemented carbides for tailor-made products. A short time ago the range of available blanks was expanded by disc-shape semi-finished heads which are successfully used for customized solutions in milling slots, grooves, threads, splines, and many more.

The needs of modern manufacturing bring more and more requests and open new application fields that require an appropriate tooling response. The history of ISCAR's **MULTI-MASTER** concludes with high versatility of tools with exchangeable heads and highlights their ability to meet growing industrial demands.

CNC Technology Requires Digitized Tools



Rows of CNC machine tools sharing their workspace with industrial robots that transport machined parts, accompanied by a minimal number of machine operators, are already a common scenario that depict modern metalworking plants and shops. CNC machines are the catalyst which created progressive computer data engineering to enable this new reality. Advanced multi-axis machines facilitate the production of very complicated shapes with minimal setups. Advanced milling and turning capabilities, coupled in multitasking machines, open new opportunities for effective process planning. A quantum leap in CNC technology enables the practical understanding of machining methods that have been theoretical for a long time, such as power skiving.

The contemporary evolution of smart manufacturing is based on network technologies. In a smart factory, CNC machines perform under the conditions of real-time and combine mutual information exchange from an environmental context that blends both real and virtual worlds. The systems interact with the context via the Internet of Things referred to as IOT. For example, the real world shows the position of a cutting tool and acting cutting forces, while the virtual world specifies 3D tool paths during an operation combined with predetermined machine stock allowance. Subsequently, the real and virtual worlds find themselves in a cutting tool where they naturally complement each other.



A digital tool component possesses vast information or data. Its elements are comprised of 3D and 2D models, estimated tool life, accumulated cutting time, possible limitations such as maximum rotational speed, optimal machining data and additional essential information.



For centuries, technical drawings were considered a common language for defining tool features. Computer aided engineering (CAE) and CNC systems require another means for data exchange. Cooperative efforts of world specialists from various engineering and scientific fields have resulted in the creation of the ISO 13399 standard, which specifies computer representations of information related to cutting tools, their holder which makes the lexicon base of the language. Adherence to this standard means that the tool digital component's platform remains independent, and computerized systems can utilize the data seamlessly. The smart factory will require additional smarter manufacturing systems and smarter tools for these systems. Information about tool properties, such as the remainder of its tool life period, a specific tool identification, service limitations, necessitates uniform rules for specifying the information and its computer representation like the ISO 13399 standard, yet much more comprehensive.



ISCAR is aware of the key importance of tool digital elements. The new company's developments relate to both cutting tools and the tool informational essentials as well. Tool assembly options in 3D and 2D formats in ISCAR's electronic catalog; **NEO-ITA**, the ISCAR digital tool adviser, on-line engineering calculations and **MATRIX**, the automated tool dispenser that is an integral part on the shop-floors of a smart factory.

From technologists working on process planning, engineers designing tool assemblies or preparing the tooling part of a complex key project, CNC programmers checking a tool path in a CAD/CAM environment, to application specialists optimizing machining operations, and even sales managers assisting in selecting a more effective tool – all might spend hours adopting the tool manufacturers' tool data to integrate with the customer's software. ISCAR's electronic catalog provides a digital twin representation of the tool assembly based on the ISO 13399 standard. This guarantees the successful communication between current and future software support in a digitized smart factory. The virtual assembly ensures fast, reliable simulation of the operation as well as collision (interference) by checking and tool path optimization and the design of workholding fixtures. As the selected machining method affects the forces acting on workpieces, and a tool configuration influences the shape of workholding elements, simulating the operation by use of the tool assembly model may be also considered an effective instrument for jig and fixture design.

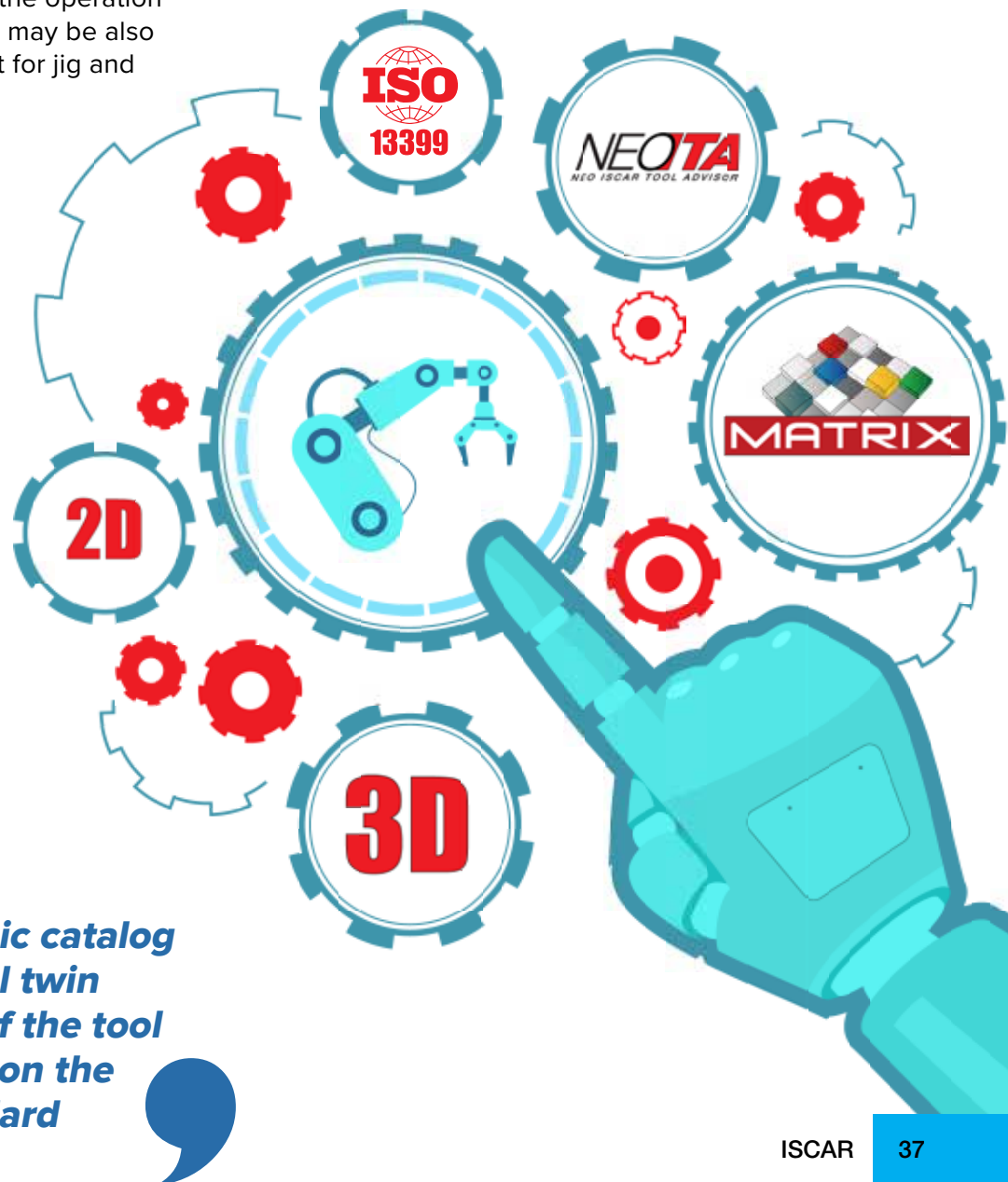

ISCAR's electronic catalog provides a digital twin representation of the tool assembly based on the ISO 13399 standard

The ISCAR tool adviser which assists users in selecting the right tool, is now reborn under the brand name **NEO-ITA** which features advanced analytics based on artificial intelligence and a big-data platform. The upgraded adviser version utilizes new capabilities such as new machine brands, material libraries, integrated machining calculations, and the ability to export p21-files as an integral part of tool recommendations.

One more useful digital assistant is the **4-PRO** an online product information and machining recommendation tool which enables tool and insert information at your fingertips. **4-PRO** scans the 2D data matrix barcode on an ISCAR tool or insert packaging label while assuring access to the necessary data on a CNC shop floor. Diverse **4-PRO** options provide product geometrical information presented in accordance with the ISO 13399 standard, and tie together inserts and tools to match up with recommended cutting speeds and feeds. **4-PRO** also bonds the insert geometry and its coating to the correct type of metal, allowing better choices at the planning stages of a given process.

Intelligent CNC machines, network technologies, information real-time exchange and virtual twins of physical objects are the necessary bricks for building manufacturing in the era of INDUSTRY 4.0.



ISCAR **INDUSTRY**
PRO

4-PRO also bonds the insert geometry and its coating to the correct type of metal, allowing better choices at the planning stages of a given process



WELCOME TO **ISCAR'S** 2023 WORLD

